



ART 561

GUIDE GRASS - GRASS SLIDES - COULISSES GRASS - GUIAS GRASS

REV 02.2019

FOIST00119

SIGE S.P.A.

60020 POLVERIGI (AN) ITALY

TEL +39 071 90 90 000 R.A. - FAX +39 071 90 90 804

WWW.SIGE-SPA.IT INFO@SIGE-SPA.IT

PRODOTTO ED ASSEMBLATO IN ITALIA / MADE AND ASSEMBLED IN ITALY / FABRIQUÉ ET ASSEMBLÉ EN ITALIE / HECHO Y MONTADO EN ITALIA

CARATTERISTICHE • FEATURES • CARACTÉRISTIQUES • CARACTERÍSTICAS

Pattumiera ad estrazione totale da 450 mm Lt.70

Full extension wastebin 450 mm Lt.70

Poubelle sortie totale 450 mm Lt.70

Cubo de basura a extracción total 450 mm Lt.70

MINUTERIA INTERNA • FITTINGS • FERRURE • FERRETERIA

N°12 3,9x13 Vite autofilettante TC a croce / Self tapping screw TC / Vis autotaraudeuse TC / Tornillo autorroscante TC

N°8 4x16 Vite autofilettante TSP a croce / Self tapping screw TSP / Vis autotaraudeuse TSP / Tornillo autorroscante TSP

N°4 M4x5 Vite cilindrica / Cylindrical screw / Vis cylindrique / Tornillo cilíndrico

N°2 M6x10 Vite / Screw / Vis / Tornillos

N°2 Rondella / Washer / Rondelle / Arandela

COMPONENTI • PARTS • COMPOSANTS • COMPONENTES

A. N°1 Box metallico / Metal box / Boîte en métal / Caja de metal

B. N°1 Kit guide Grass / Kit grass slides / Kit glissières grass / Kit de guías grass

C. N°1 Coppia carter guide / Kit slide cover / Kit carter pour glissières / Kit carter para las guías

D. N°2 Lamiera reggi coperchio / Metal plate lid holder

Support pour couvercle tôle / Placa de metal para sostener la tapa

E. N°1 Coperchio / Lid / Couvercle / Tapa

F. N°1 Coppia attacco antina / Kit door fixing brackets

Kit de pattes de fixation pour porte / Kit soportes de fijación de la puerta

G. N°2 Cover attacco antina / Door fixing cover

Cache-vis pour pattes de fixation / Cover para los soportes de fijación

H. N°4 Tappo / Stopper / Bouchon / Tapón

I. N°2 Secchio pattumiera 35 Lt. / Wastebin Lt.35 / Poubelle Lt.35 / Cubo de basura Lt.35

UTENSILERIA • TOOLS • OUTILS • INSTRUMENTOS



MANUTENZIONE • MAINTENANCE • ENTRETIEN • MANTENIMIENTO

Pulire con un panno morbido ed asciutto. Evitare l'uso di solventi e/o abrasivi.

Clean with a soft, dry cloth. Avoid using solvents or abrasive.

Nettoyez avec un chiffon sec et doux. N'utilisez pas aucun solvant ou produit abrasif.

Limpia con paño suave y seco. Evitar el uso de solventes y/o abrasivos.

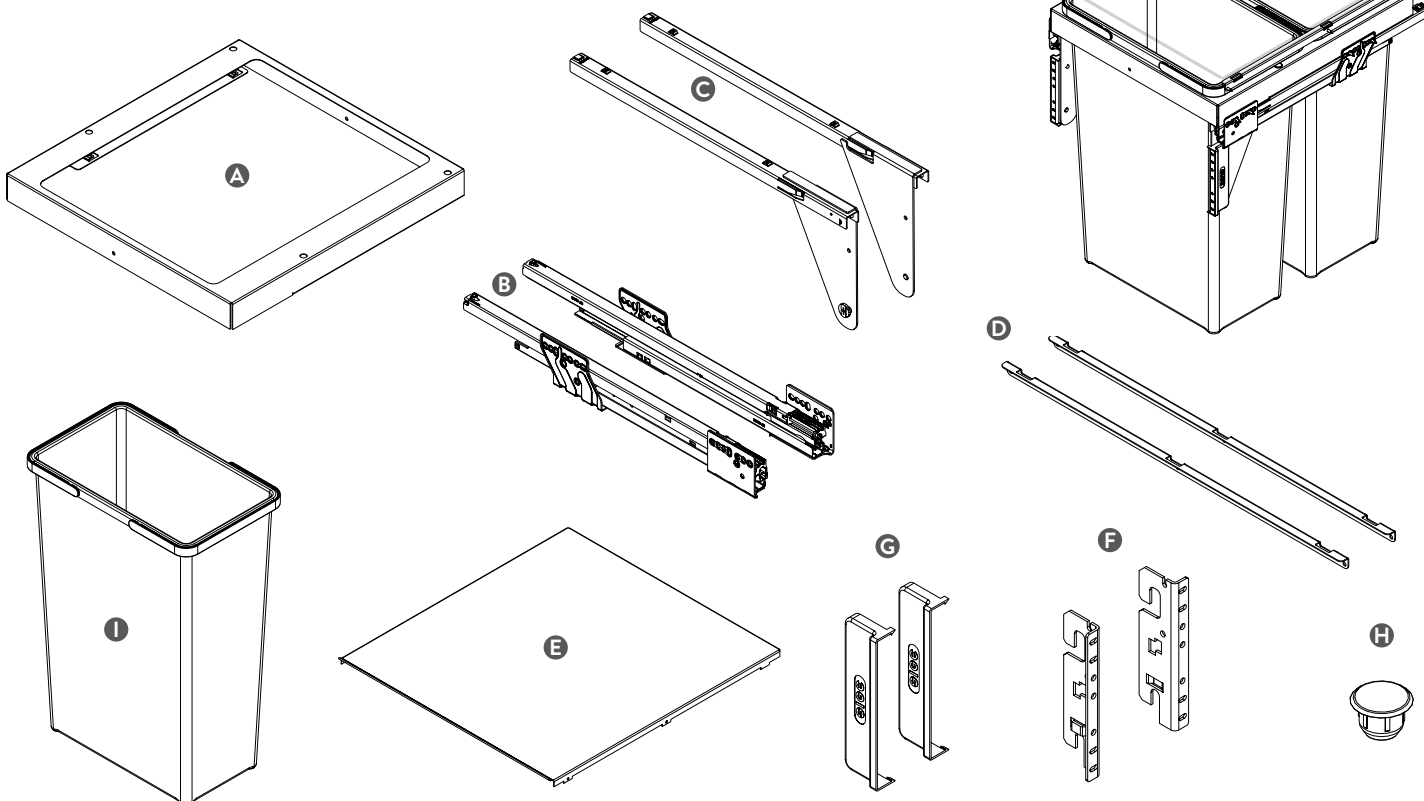
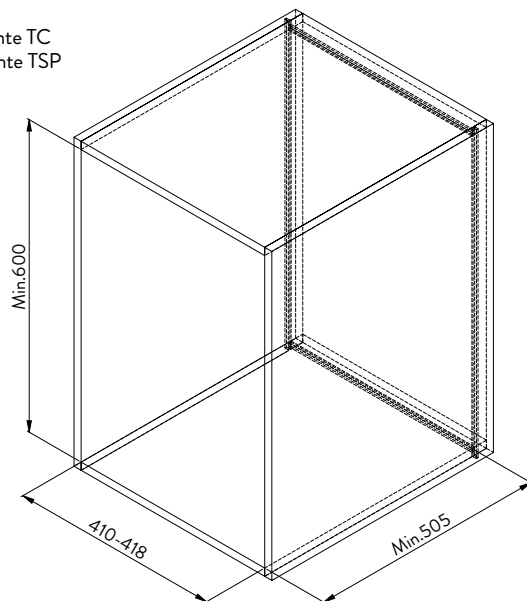

N°4 3,9x13 N°8 4x16



1

Fissare le guide C e le lamiere reggi coperchio D rispettando le quote.

Fix the Grass slides C and the metal plate lid holder D according to the dimensions.

Fixez le kit glissières Grass C et le support pour couvercle tôle D en respectant les dimensions.

Fijar el kit de guías Grass C y la placa de metal para sostener la tapa D respetando las medidas.

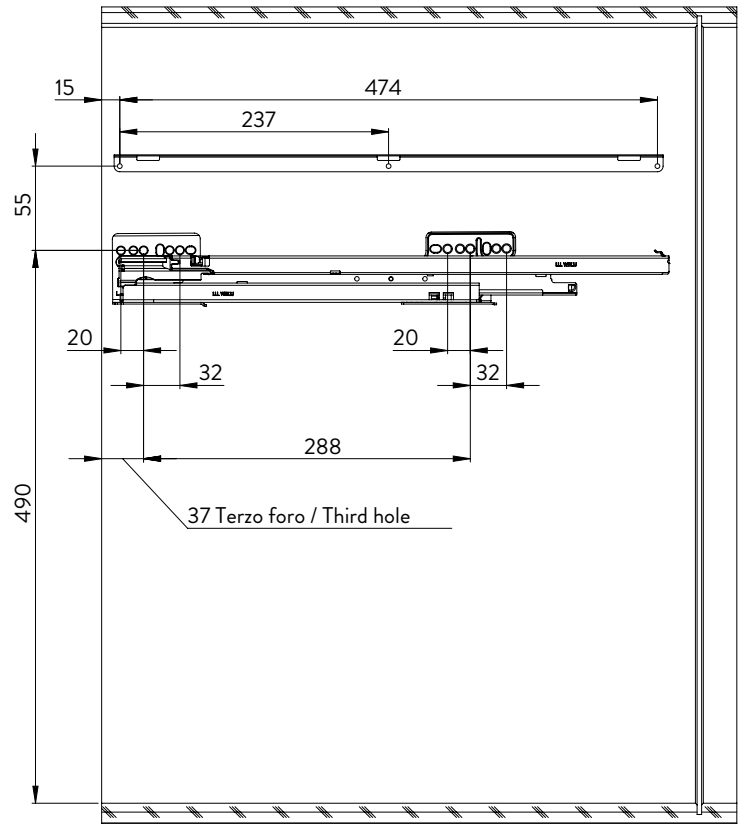
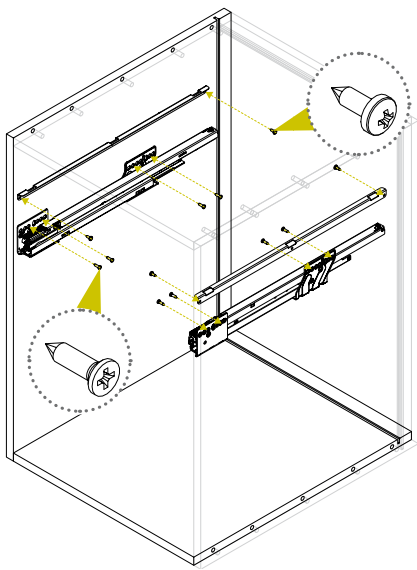

2

Inserire la coppia carter guide C nelle guide B.

Put the kit slide carter C into the Grass slides B.

Insérer le kit carter pour la glissière C dans les glissières B.

Úolocar el kit carter para las guías C sobre las guías Grass B.

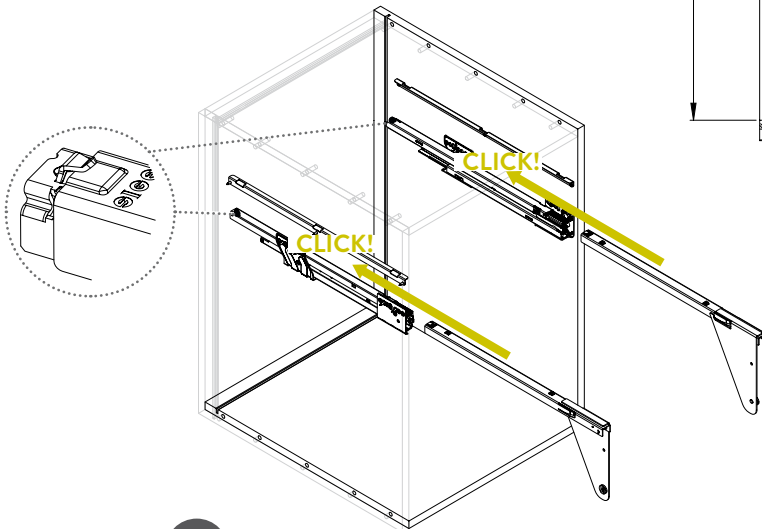

N°4 M4x5



3

Avvitare il box metallico A nei carter guide C mediante le apposite viti.

Screw the metal box A into the kit slide carter C by using the specific provided viti.

Visser la boîte en métal A dans le kit carter pour glissières C avec les spécifiques vis fournies.

Atornillar la caja de metal A en el kit carter para las guías C con los tornillos provistos.

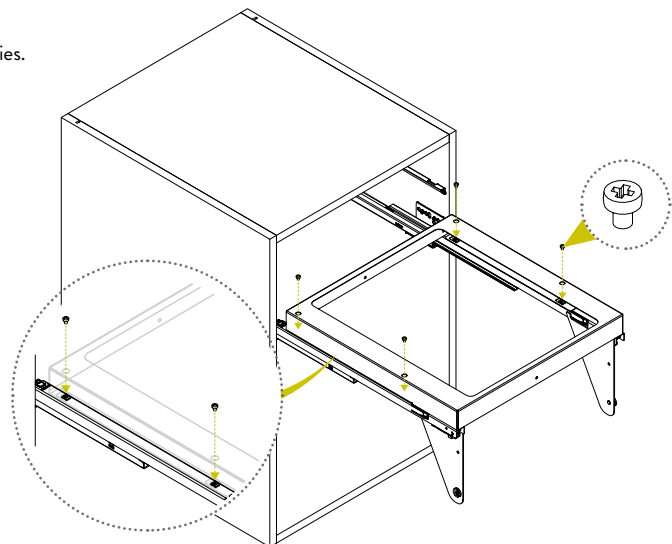
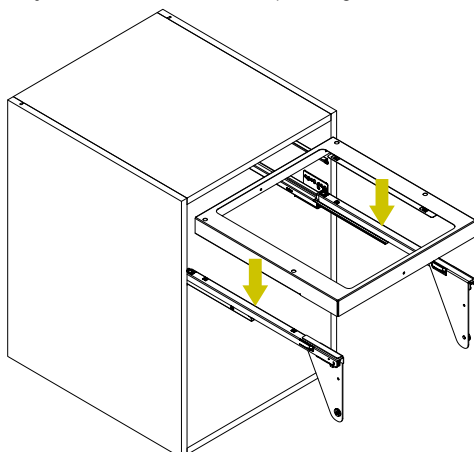

4

N°6 3,9x13



Fissare la coppia attacco antina F nell'anta, rispettando le quote.
Assemble the kit door fixing brackets F according to the dimensions.

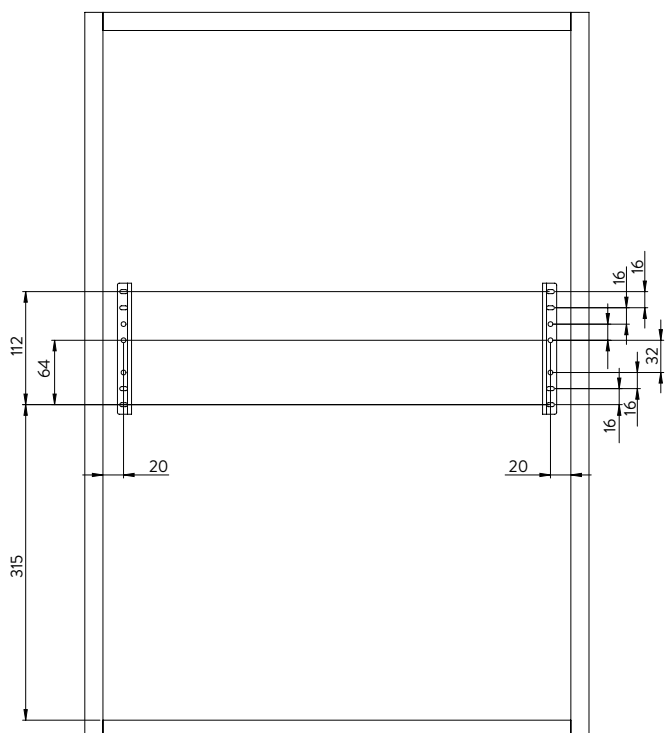

Fixer le kit de pattes de fixation F sur la porte du meuble en respectant les dimensions.
Fijar el kit soportes de fijación de la puerta F en la puerta respetando las medidas.

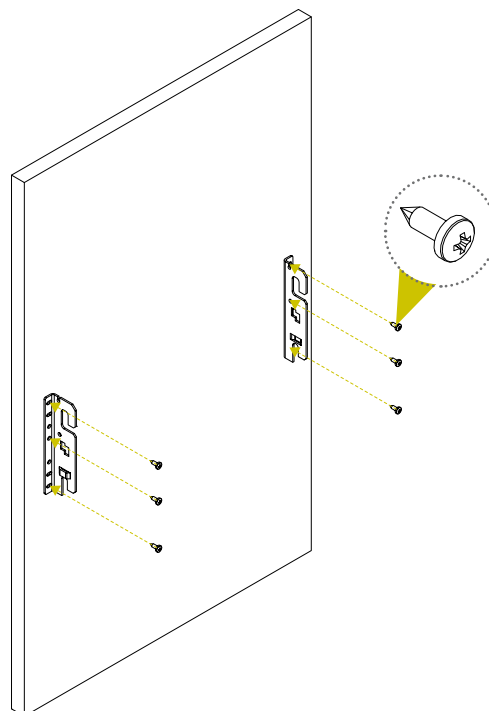

5

N°2 M6x10



Pre-montare le viti M6x10 con le rondelle e montare l'antina sul carter C come mostrato.
Pre-assemble the M6x10 screws and washers than mount the door on the carter C as shown.

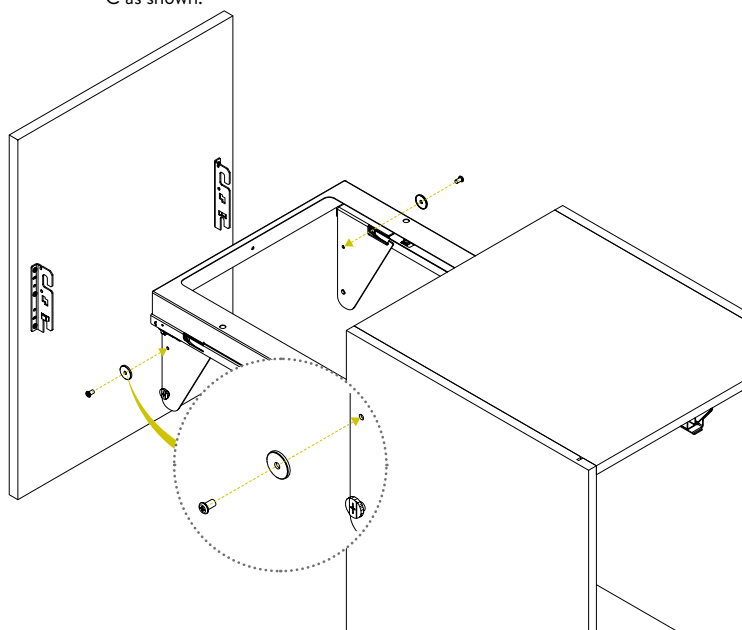

Pré-assembler les vis M6x10 et les rondelles, monter selon indications la porte sur le carter C.

Montar previamente los tornillos M6x10 con las arandelas y montar la puerta sobre el carter C como se indica.

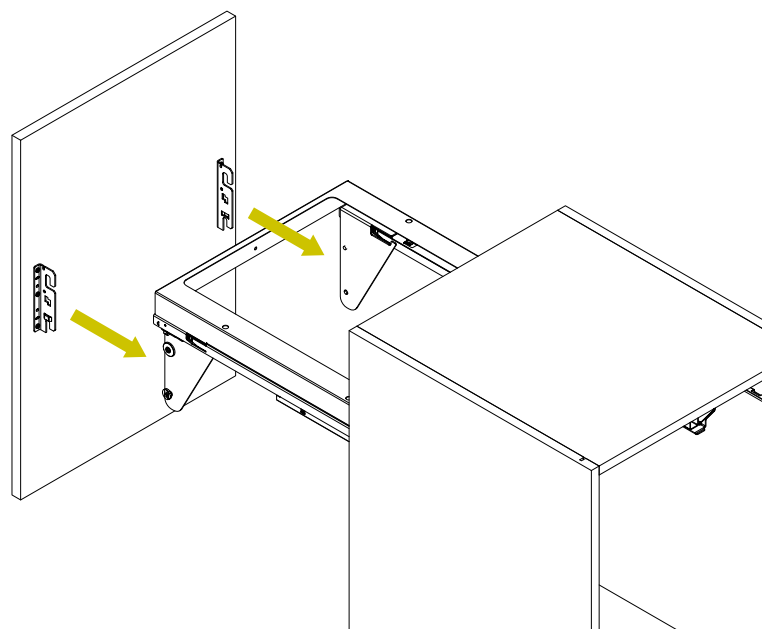

6

Regolare l'antina su e giù tramite l'eccentrico.
 Adjust the door up and down by turning the eccentric screw.
 Ajustez la porte de haut en bas en tournant la vis excentrique.
 Ajuste la puerta hacia arriba y hacia abajo girando el tornillo excéntrico.

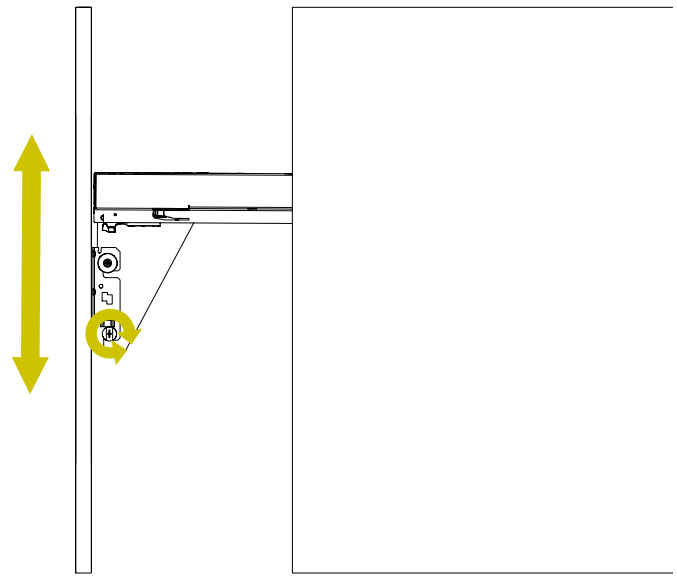
**7**

Regolare l'inclinazione avanti ed in dietro dell'anta, quindi serrare le due viti M6x10.
 Adjust the door inclination to the front or to the back, then tight the two M6x10 screws.
 Ajuster l'inclinaison de la porte à l'avant ou à l'arrière, puis serrer les deux vis M&x10.
 Ajuste la inclinación de la puerta hacia delante o hacia atrás, apretando los dos tornillos M6x10.

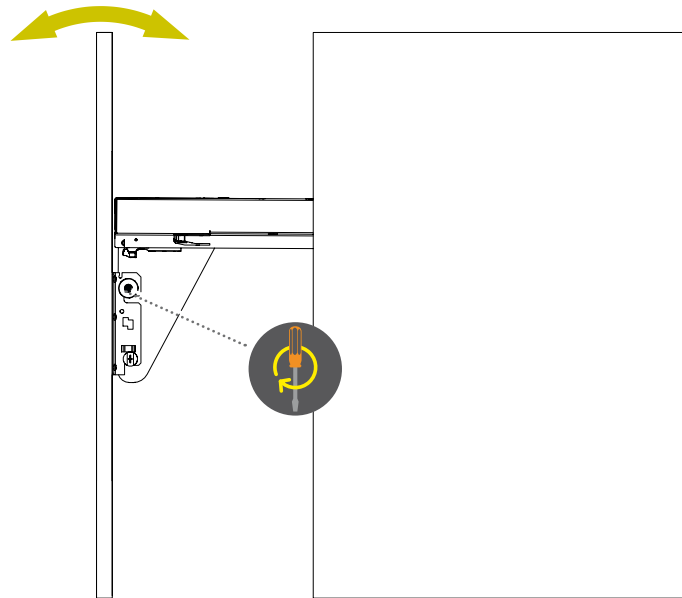
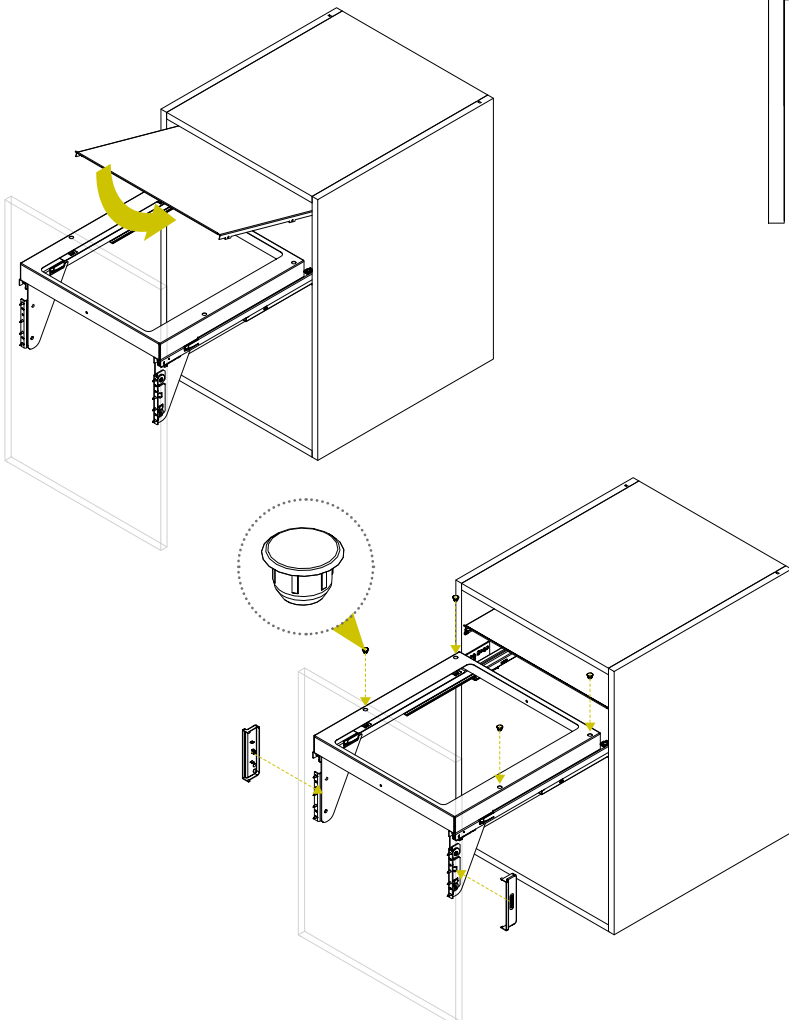
**8****9**